

TELEVAC TELEVAC TELEVAC TELEVAC



TELEVAC
A DIVISION OF *THE FREDERICKS COMPANY*
2400 PHILMONT AVE.
HUNTINGDONVALLEY, PA 19006



TABLE OF CONTENTS

<u>SECTION</u>	<u>TITLE</u>	<u>PAGE</u>
1	Introduction and Safety Instructions	
2	User Controls	
3	Specifications	
4	Operation	
5	Analog Output	
6	Digital Interface	
7	Maintenance	
8	I / O Connector	
9	Dimensions	
10	Error Message List	
11	Troubleshooting	



CC-10 INSTRUMENT MANUAL

1.0 Introduction and Safety Instructions

1.0.1 Product Overview:

The CC-10 is a self-contained, compact wide range vacuum gauge and controller employing the latest sensor technology. The CC-10 is able to replace multiple traditional gauges and provides the user with measurement capability from atmospheric pressure to 10^{-9} Torr. The gauge requires 22-26 VDC input power and provides the user with a digital pressure indication, analog output and RS485 digital communications. Three independent set points can be addressed from the instrument's control panel, from a tethered remote display module or via RS485.

1.2 Sensor Technology:

The CC-10 uses two sensor types to seamlessly measure a pressure range of 12 decades. An crystal sensor is used to measure from atmospheric pressure to 10^{-4} Torr and a double inverted magnetron cold cathode is used to measure from 10^{-2} to 10^{-9} Torr.

1.2.1 Crystal Sensor Operating Principle

The crystal sensor is a simple tuning-fork shaped quartz oscillator that's similar to the oscillators commonly used in wrist watches. The electrical impedance of the oscillation depends upon the pressure of the gas that surrounds the quartz oscillator, because the resistance to the oscillation (as caused by friction between the quartz surface and gas molecule), varies as the pressure changes. The crystal sensor measures the electrical impedance of the quartz oscillator and its circuitry converts it to the pressure value.

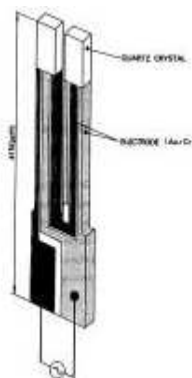

Crystal Sensor

1.2.2 Cold Cathode Operating Principle

The double inverted magnetron cold cathode sensor measures pressure by ionizing the residual gases in a magnetron discharge. The body of the sensor serves as the cathode and is at ground potential. The anode operates at as much as 4000 volts. A permanent magnet traps electrons in the sensor to sustain the discharge at a very low pressure. This type of sensor; like all ionization sensors, is sensitive to gas type, but unlike conventional ionization gauges, has no filaments to burn out, can operate continuously at higher pressure and is considerably more rugged and reliable.



CC-10 INSTRUMENT MANUAL

1.3 Safety Instructions

START BY READING THESE IMPORTANT SAFETY INSTRUCTIONS AND NOTES



These safety alert symbols in this manual or on the product rear panel mean Cautions - personal safety, property damage or danger from electrical shock. Read these instructions carefully.

In these instructions the word “product” refers to the CC-10 and all of its approved parts and accessories.

NOTE: These instructions do not and cannot provide for every contingency that may arise in connection with the installation, operation, or maintenance of this product. Should you require further assistance, please contact Televac at the address on the title page of this manual.

This product has been designed and tested to offer reasonably safe service provided in it's installed, operated and serviced in strict accordance with these safety instructions.



Failure to comply with these instructions may result in serious personal injury, including death, or property damage.

These safety precautions must be observed during all phases of operation, installation, and service of this product. Failure to comply with these precautions or with specific warnings elsewhere in this manual violates safety standards of design, manufacture, and intended use of the instrument. Televac disclaims all liability for the customer's failure to comply with these requirements.



The service and repair information in this manual is for the use of Qualified Service Personnel. To avoid shock, do not perform any procedures in this manual or perform any Servicing on this product unless you are qualified to do so.

- ✓ READ Instructions – Read all safety and operating instructions before operating the product.
- ✓ RETAIN instructions – Retain the Safety and Operating Instructions for future reference.
- ✓ HEED warnings – Adhere to all warnings on the product and in the operating instructions.
- ✓ FOLLOW instructions – Follow all operating and maintenance instructions.
- ✓ ACCESORIES – Do not use accessories not recommended in this manual as they may require a technician to restore the product to its normal operation.



To reduce risk of fire or electric shock, do not expose this product to rain or moisture.



CC-10 INSTRUMENT MANUAL

Safety Instructions (cont.)



Objects and Liquid Entry – Never push objects of any kind into this product through openings as they may touch dangerous voltage points or short out parts that could result in a fire or electric shock. Be careful not to spill liquid of any kind onto the products.



Do not substitute parts or modify instrument. Because of the danger on introducing additional hazards, do not install substitute parts or perform any unauthorized modifications to the product. Return the product to Televac for service and repair to ensure that safety features are maintained. Do not use this product if it has unauthorized modifications.



CC-10 INSTRUMENT MANUAL

2.0 User Controls

2.1 Front panel

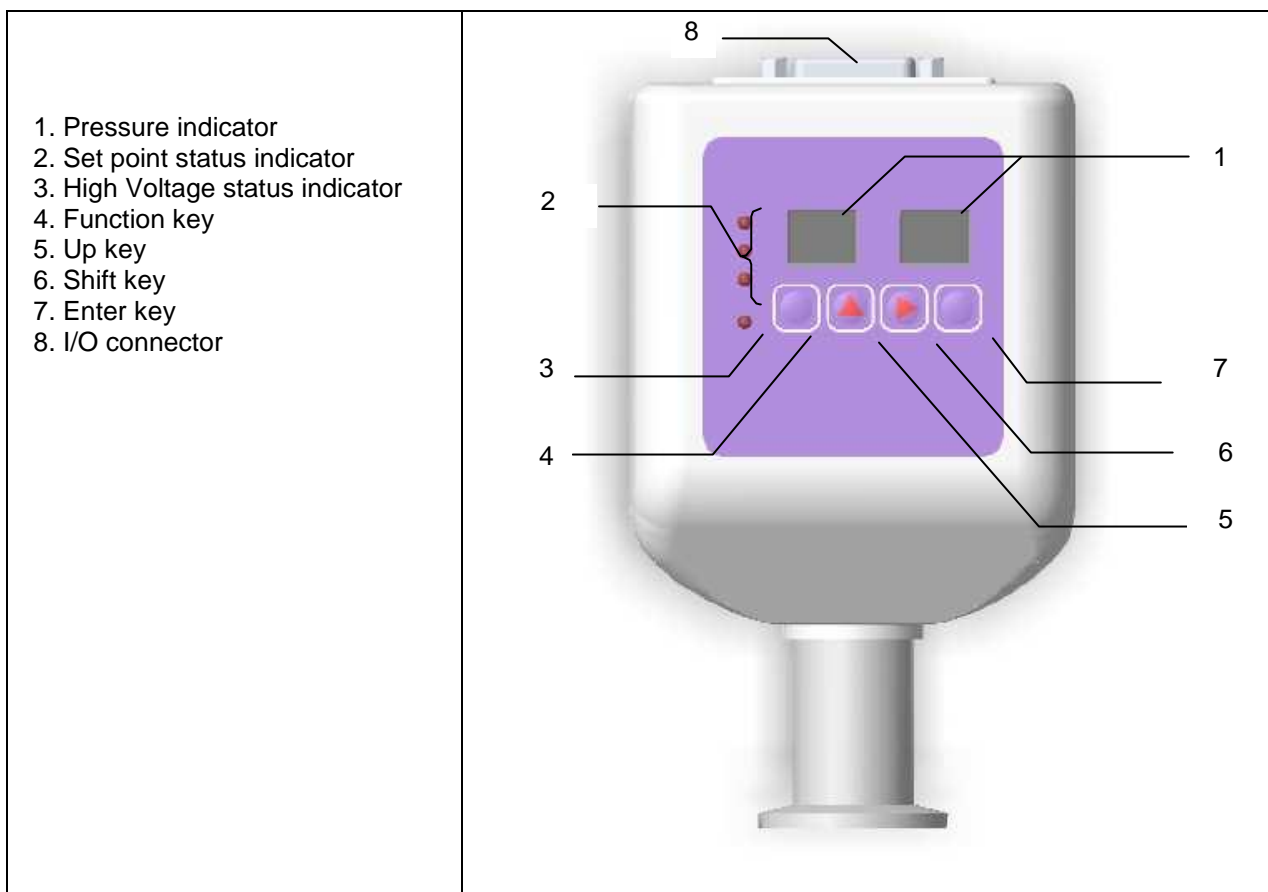



CC-10 INSTRUMENT MANUAL

2.2 Rear panel

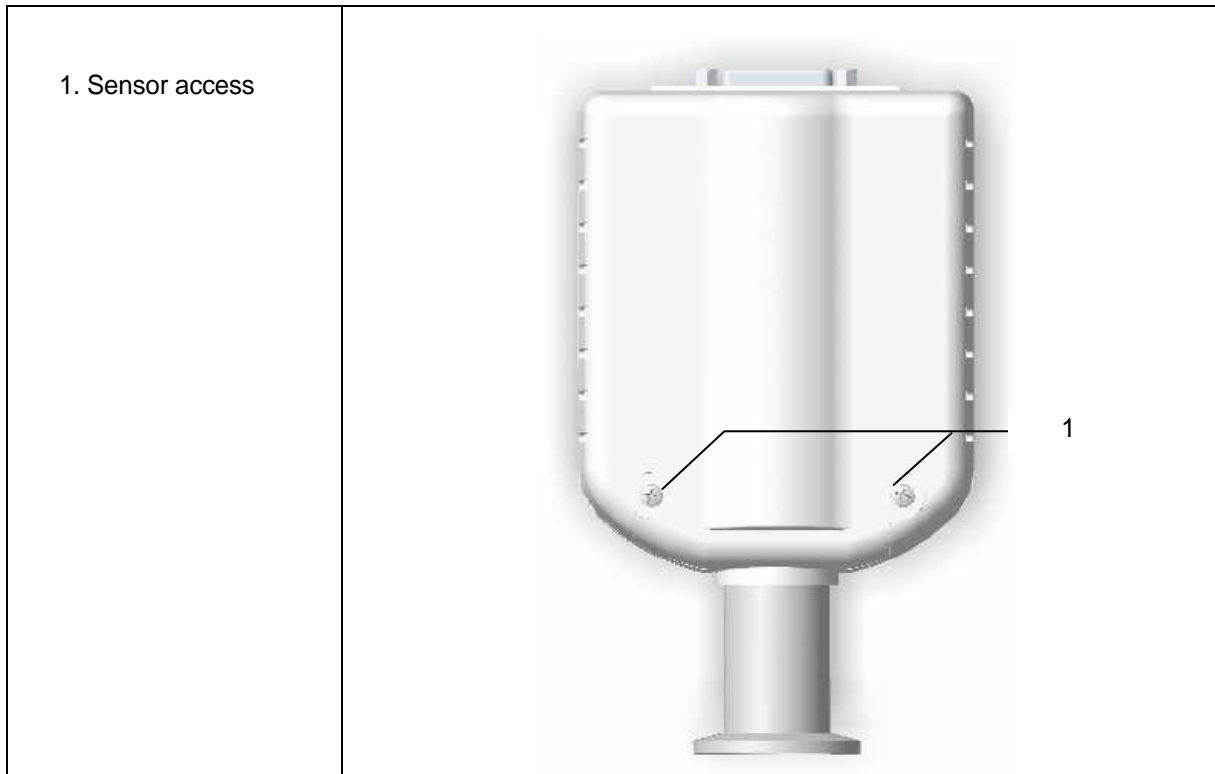

2.3 Sensor

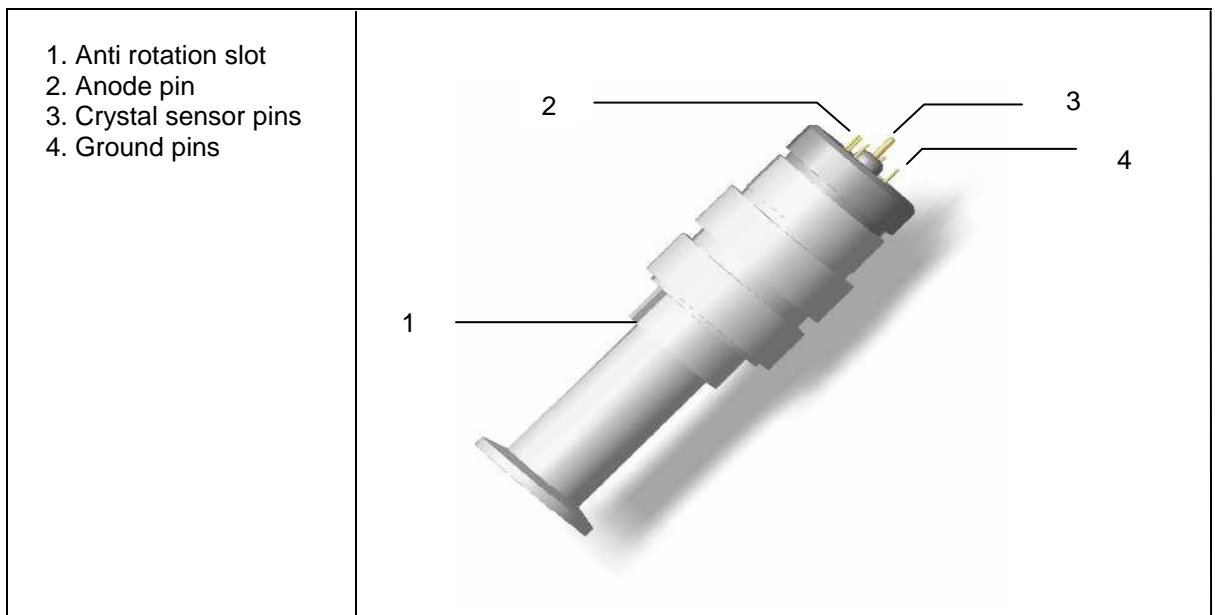



CC-10 INSTRUMENT MANUAL

3.0 Specifications

Measurement range	760 Torr to 1×10^{-9} Torr								
Accuracy	<table border="0"> <tr> <td>± 0.2 of decade</td> <td>10E-9 to 10E-3 Torr</td> </tr> <tr> <td>$\pm 15\%$</td> <td>$2 \times 10E-3$ to $1 \times 10E-1$</td> </tr> <tr> <td>$\pm 10\%$</td> <td>$2 \times 10E-1$ to $1 \times 10E$ Torr</td> </tr> <tr> <td>$\pm 5\%$</td> <td>10 to 760</td> </tr> </table>	± 0.2 of decade	10E-9 to 10E-3 Torr	$\pm 15\%$	$2 \times 10E-3$ to $1 \times 10E-1$	$\pm 10\%$	$2 \times 10E-1$ to $1 \times 10E$ Torr	$\pm 5\%$	10 to 760
± 0.2 of decade	10E-9 to 10E-3 Torr								
$\pm 15\%$	$2 \times 10E-3$ to $1 \times 10E-1$								
$\pm 10\%$	$2 \times 10E-1$ to $1 \times 10E$ Torr								
$\pm 5\%$	10 to 760								
Pressure display	Digital display of two mantissa digits and two exponent digits								
Pressure unit	Torr / Pascal selectable								
Set point	<p>Three set points (one independent set point and two common ground set points)</p> <p>Setting method: 1 By local switches 2. Through communication interface</p> <p>Contact rating: DC50V 0.12A</p>								
Analog output	<p>Log or combined output selectable</p> <p>Voltage: 0 – 10V</p>								
Ambient temperature & Humidity (operating)	0-50C / 10-90% RH								
Power requirement	22-26vdc								
Power consumption	8w maximum								
Weight	1.54 lbs. (NW25 model)								
Size	3.7" wide X 2/78" deep X 6.3" high (NW25 model)								

NOTE: Bake temperature: Max. 150° C (with electronics module removed).



CC-10 INSTRUMENT MANUAL

4.0 Operation

4.1 Starting the measurement

Connect D sub-connector to the instrument and supply power after installing CC-10 to the vacuum system and properly connecting necessary wires. When the power is supplied the unit runs an internal check program for several seconds then goes to measurement mode. Pressure display will appear on the display.

4.2 Locking parameters In order to prevent unintended parameter changing the “parameter lock” function is provided. To switch this function between enabled and disabled follow the procedure below.

When shipped, it is set to disabled.

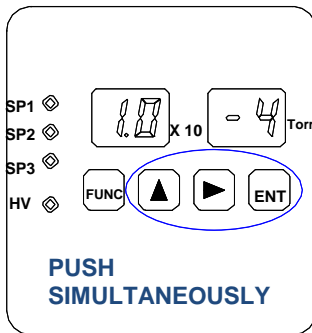

When in the measure mode, push “↑” key, and “→” key, “ENT” key simultaneously.

All LEDs are lit for a moment, then established status will alter.

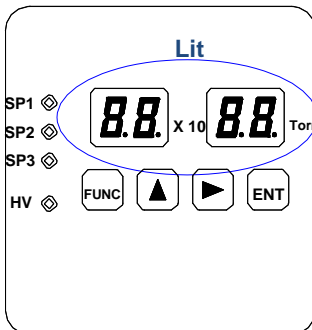
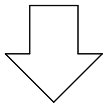

4.3 Display modes and mode changing

There are nine modes that are changed by pushing [FUNC] key and [ENT] key. Those are;

1. Measurement mode
2. SP1 setting mode (SP1L setting, SP1H setting)
3. SP2 setting mode (SP2L setting, SP2H setting)
4. SP3 setting mode (SP3L setting, SP3H setting)
5. Crystal gauge ATM (atmospheric pressure) adjustment mode (Manual operation)
6. Crystal gauge Zero adjustment mode (Manual operation)
7. Analog output setting mode
8. Pressure unit selection mode
9. Communications set mode
10. Crystal sensor property mode



**CC-10
INSTRUMENT MANUAL**

Changing modes

(1) By pushing [FUNC] key the mode moves cyclically as; 1 → 2 → 3 → 4 → 5 → 6→7 → 8 →9→1

(2) When the mode moves to SPx(x is 1,2 or 3) set mode, SPxL set is selected first. Pushing [ENT] key stores the value and moves to SPxH set mode. In SPxH mode by pushing [ENT] key the value is stored then it returns to measure mode.

*If [FUNC] key is pushed instead of [ENT] button in either SPxL or SPxH mode the value is not stored and the mode moves to the next one.

(3) In any other mode than SPx set modes, by pushing [ENT] key the value is stored and the mode returns to the measure mode. (If [FUNC] key is pushed instead, the value is not stored and the mode moves to the next mode.

(4) If, in any program mode, there are no operation for 30 seconds it automatically moves back to measure mode. **(There are some exceptions)**

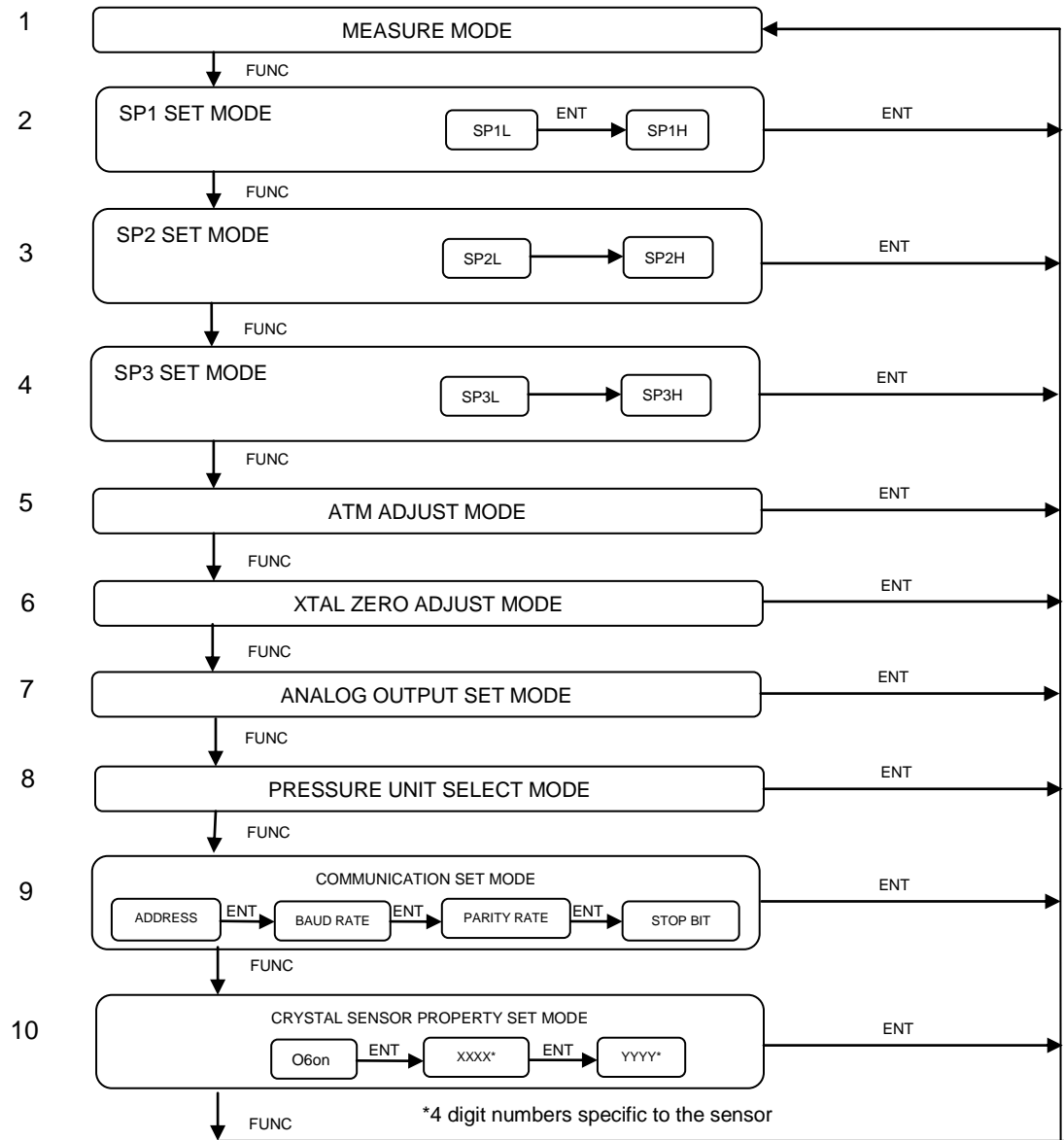



CC-10 INSTRUMENT MANUAL

4.4 Set Point

General Description – There are 3 set points in this instrument and each set point has hysteresis characteristics and consists of two set values; upper threshold and lower threshold. In this manual the upper threshold value of the set point 1 is expressed as SP1H and lower threshold as SP1L. LED's on the front panel displays the status of each set point. They lit when the pressure reaches at the lower threshold and at the same time set point relays activate. If the pressure rises again and exceeds upper threshold the LED's go off and the relays deactivate. The both threshold value of each 3 set point can be set independently.

Set value of set points

Upper threshold of each set point (SP1H-SP3H) cannot be set below the lower threshold value (SP1L-SP3L). If it does not meet this condition the upper and the lower threshold become the same value.

Hysteresis The hysteresis characteristic is installed to prevent chattering of the relays. Therefore, there are some response differences near the set point.

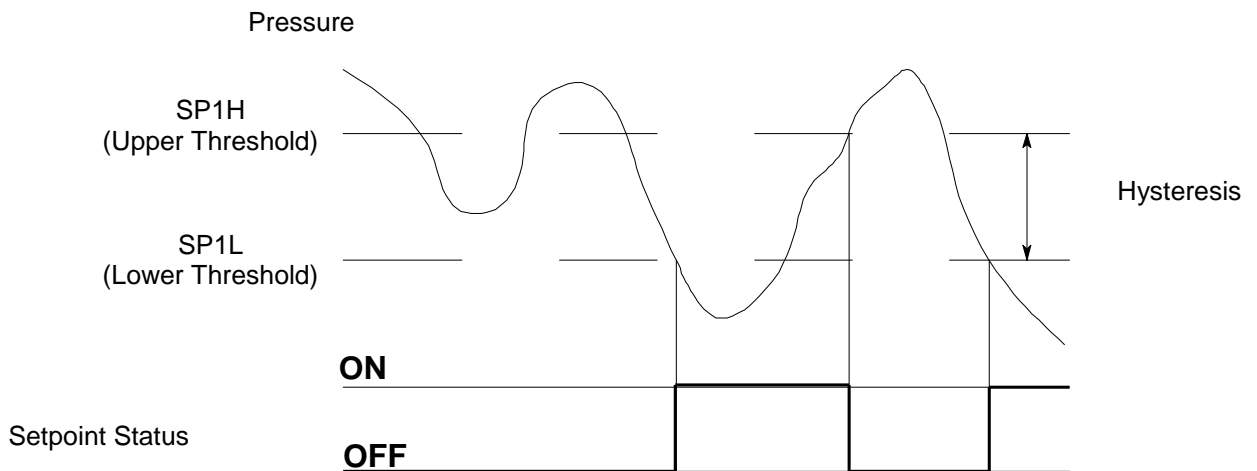



CC-10 INSTRUMENT MANUAL

4.5 Explanation of each mode

Measurement Mode

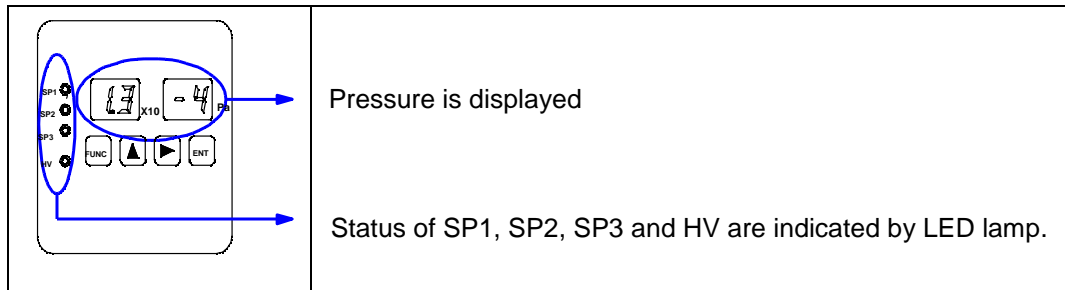

Pressure is displayed on the main display and the status of SP (set point) and HV (high voltage) are indicated by LED lamp. Whenever power is turned on this mode is selected first. Also the unit returns to this mode when one of the following situations is happened.

- (1) In any program modes when a set of the parameters are stored by pushing [ENT] key or
- (2) When the unit travels through all modes by pushing [FUNC] key one after another. or
- (3) While in program mode and there is no operation for about 30 second.



**CC-10
INSTRUMENT MANUAL**

SP1 Set Mode

In this mode value of SP1L and SP1H can be set.

SP1 mode : When “parameter lock” is enabled any parameter change can not be done and only displaying the current parameters is possible. Make sure if lock is disabled before the programming. (Refer to 4.2)

SP1 lamp blinks when SP1 setting mode is selected. Characters of “SP 1L” appear in the main display then the pre set value appears. The first digit of the mantissa blinks.

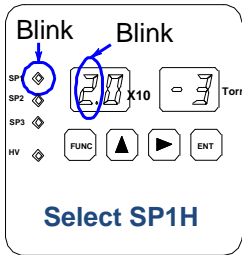
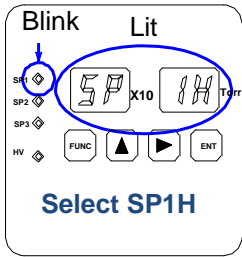
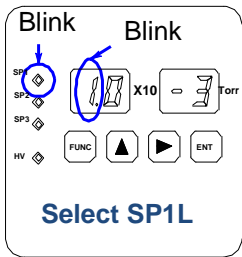
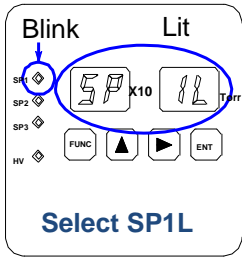

To change the set value, follow the procedures below.

- (1) Select the digit to be changed by horizontal arrow key [→].
- (2) Change the value by vertical arrow key [↑].
- (3) By pushing [ENT] key the unit moves to SP1H set mode.

* If, instead, [FUNC] key is pushed the unit skips SP1H then moves to SP2L mode. Note that the new set value of SP1L is not stored in this operation.

When SP1L is determined the unit moves to SP1H set mode. The character of “SP 1H” is shown in the display then the pre-set value is appears. The first digit will blinks prompting the entry of the new value.

To change the set value, follow the procedures below.

- (1) Select the digit to be changed by horizontal arrow key [→].
- (2) Change the value by vertical arrow key ↑
- (3) By pushing [ENT] key the values of both SP1L and SP1H are registered and the unit returns to measure mode.

* If, instead, [FUNC] key is pushed the values are not registered and the unit moves to SP2L mode.



CC-10 INSTRUMENT MANUAL

SP2 ,SP3 Setting Mode The settings of SP2L, SP2H, SP3L and SP3H are possible. Follow the same procedure as SP1L/SP1H setting.

The crystal gauge atmospheric pressure adjust mode The crystal sensor which covers pressures from Atmosphere to about 10 millitorr need to be calibrated at atmosphere when the instrument is first installed. Because the gauge is factory calibrated before shipment, the calibration at user site is not usually necessary unless the physical elevation of the user's location is substantially above sea level. When the crystal sensor is replaced for maintenance or if the displayed value at atmosphere is shifted, perform the calibration as follows.

The crystal gauge atmospheric pressure adjustment mode: when "parameter lock" is enabled this adjustment is not possible. Make sure if lock is disabled before the programming. (Refer to 4.2)

8-5

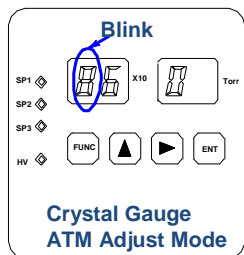
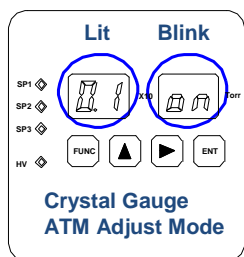

The character "01 on" on the display shows the unit is in this mode. Make sure the system is vented to atmosphere then push [ENT] key. It triggers the adjustment, instructing the sensor to fit the measurement to the pre-set atmosphere value at the event.

*As to the pre-set atmosphere value see below.

Note: If, by some mis-operation, the adjustment is triggered when the system is in vacuum "ErrA" is displayed and the adjustment will not be completed.

The unit regards the crystal sensor signal as the pre-set atmosphere pressure and adjusts the measurement to fit the value. The default atmospheric pressure value is 760 Torr. If actual atmospheric pressure is considerably different from 760Torr (for instance a high altitude locale) changing the atmosphere value is necessary. To change the Atmosphere value setting, follow the procedure below.

(1) Push horizontal arrow key [→] to indicate the current set value.

(The set value is displayed in Torr unit.) The first digit will blink.

(2) Select the digit to be changed with [→] key. Then select the value by vertical arrow key[↑].

(3) Push [ENT] key to register the new set value. The unit returns to measure mode.

* These procedures only change the Atmosphere pressure value. To perform the Atmospheric pressure adjustment, enter this mode again and press [ENT] key.

* When the unit shipped the value is set at 760 Torr. This procedure is not necessary unless the customer site is high above sea level and the Atmosphere pressure is much lower than 760 Torr.

Note: The same adjustment can be triggered from I/O pin #14. See section 8.



CC-10 INSTRUMENT MANUAL

Crystal gauge zero adjustment mode In this mode, it is possible to manually make a zero adjustment of the crystal gauge. Usually this adjustment is not necessary, because it is performed automatically every time the pressure reaches 3.0×10^{-3} Torr. When the crystal sensor is replaced for maintenance or if the zero has shifted, a manual zero adjustment might be required.

Crystal gauge Zero adjustment mode: When “parameter lock” is enabled this adjustment is not possible. Make sure if lock is disabled before the programming. (Refer to 4.2)

The character “02 on” on the display shows the unit is in this mode. Pushing [ENT] key triggers the zero adjustment instructing the sensor to fit the measurement to zero at the event.

Note: The same adjustment can be triggered from I/O pin #6. See section 8.

Analog output setting mode. The analog output can be selected from the Log output mode or the combined output mode. When the Log output is selected, it is necessary to set the width voltage of one decade and the full scale voltage. If the optional display unit DS-10 is used, the output mode will have to be set accordingly.

In this section only the operation will be explained. A detail of the analog output is described in the next section.

The analog output setting mode: When “parameter lock” is enabled any parameter change can not be done and only displaying the current parameters is possible. Make sure if lock is disabled before the programming. (Refer to 4.2)

8-7

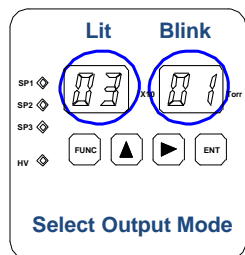

When the analog output setting mode is selected, “03” is appear on the left side two digit of the display. The right side two digit of the display blink and show the out put mode.

01: Log output 02: Combined output 03: Output for the display unit DS-10.
The change of the setting should be made according to the following procedures.



**CC-10
INSTRUMENT MANUAL**

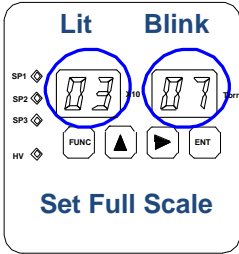
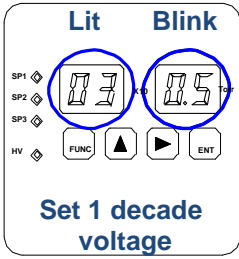

To select the Log output mode and set the width of one decade 0.5(V)
(Width of one decade can be set either 0.5V or 1.0V.)
(1) Set the blinking display to 01 by [↑] key then push [ENT] key to select Log output mode.
(2) Blinking value becomes to show the one decade width. Set the value 0.5(V) then push [ENT] key.
(3) Blinking value becomes to show the full scale voltage. Set the value between 7 to 10V then push [ENT] key. The unit returns to measure mode.

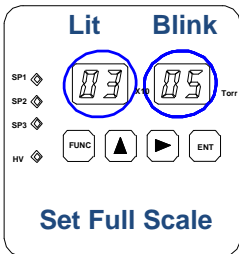
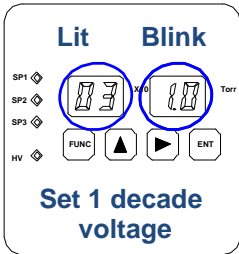

To select the Log output mode and set the width of one decade 1.0(V)
(1) Set the blinking display to 01 by [↑] key then push [ENT] key to select Log output mode.
(2) Blinking value becomes to show the one decade width. Set the value 1.0(V) then push [ENT] key.
(3) Blinking value becomes to show the full scale pressure. When 1.0V decade is selected maximum voltage is automatically set to 10V and full scale pressure corresponding to 10V can be set here. Select value from 00(1.0x10⁰Torr) to 03(1.0x10³Torr). Push [ENT] key to register the value after selecting the full scale pressure. The unit returns to measure mode.

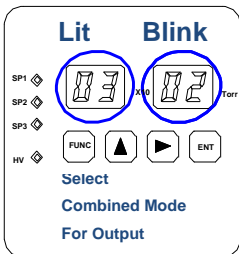

To select the combined output mode set the blinking digit at 02 by [↑] key then push [ENT] key to register the mode. The unit returns to measure mode.



**CC-10
INSTRUMENT MANUAL**

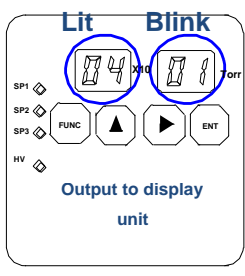

To select output for DS-10 display unit set the right side two digits that are blinking at 03 then push [ENT] key to register the parameter. The unit returns to measure mode.

When “parameter lock” is enabled the current parameter is displayed in the right side two digits.

- 01: Log output -> Width of one decade -> full scale
- 02: combined output
- 03: out put for DS-10 display unit

Explanation of the output full scale If the Log output is selected and the width of one decade is set to 0.5(V), the range of the output voltage corresponding to the effective voltage of 1V to 10V is shown in the figure below.

$$0.5V/\text{decade} \times 12 \text{ decade} = 6V$$

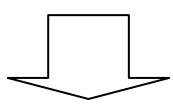
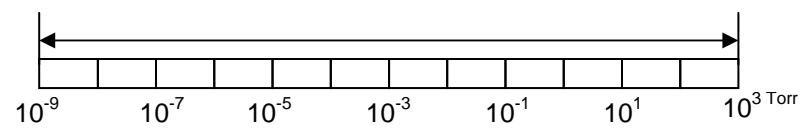

	1	2	3	4	5	6	7	8	9	10	
Effective voltage range (V)											
ATM set at 10 V			10^{-9} Torr							10^3 Torr	
ATM set at 9 V		10^{-9} Torr							10^3 Torr		
ATM set at 8 V		10^{-9} Torr							10^3 Torr		
ATM set at 7 V	10^{-9} Torr							10^3 Torr			

If the Log output is selected and the width of one decade is set to 1.0(V), the range of the output voltage corresponding to the effective voltage of 1V to 10V is shown in the figure below.

$$1.0V/\text{decade} \times 12 \text{ decade} = 12V$$



**CC-10
INSTRUMENT MANUAL**

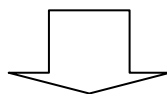
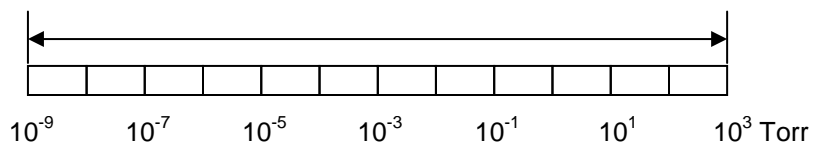

Effective voltage range (V)	1	2	3	4	5	6	7	8	9	10
Set 10V = $10^{2(0)}$ Pa (Torr)			10^{-9} Torr							10^0 Torr
Set 10V = $10^{3(1)}$ Pa (Torr)				10^{-8} Torr						10^1 Torr
Set 10V = $10^{4(2)}$ Pa (Torr)					10^{-7} Torr					10^2 Torr
Set 10V = $10^{5(3)}$ Pa (Torr)						10^{-6} Torr				10^3 Torr



CC-10 INSTRUMENT MANUAL

Pressure unit selection mode

It is a mode the pressure unit can be selected. Pa, Torr and mbar are available.

Blink

The pressure unit selection mode: When “parameter lock” is enabled any parameter change can not be done and only displaying the current parameters is possible. Make sure if lock is disabled before the programming. (Refer to 4.2)

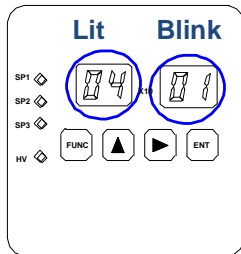

04 is displayed on the left side two digits to show pressure unit selection mode is selected. On the right side two digits selected unit is displayed.

01: Pa

02: Torr

03: mbar

To change the unit select the value by the [↑] arrow key then push [ENT] key to register the parameter. The unit returns to measure mode.

Notes : Note that the numerical set values (for instance set point values) are not changed even if the unit is changed.



CC-10 INSTRUMENT MANUAL

Communication setting mode To communicate with the host computers, address, baud rate, parity bit and stop bit are to be programmed. Follow the procedures below. Note: As to the communication functions refer to the section 5.

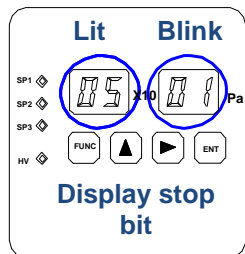
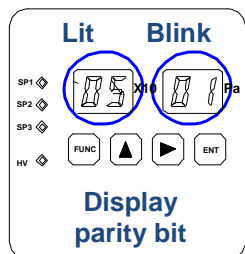
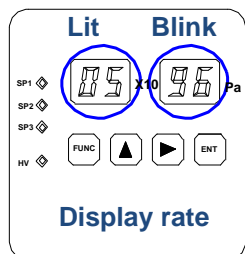
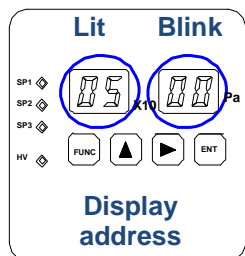

Communication setting mode : When “parameter lock” is enabled any parameter change can not be done and only displaying the current parameters is possible. In this case by pushing ENT key, the display in the right two digits will be changed in the following order; address, data rate, parity bit then stop bit. Make sure that the lock is disabled if you need the programming.

“05” display appears on the left two digits that means the gauge is in communication setting mode. The right two digits (blinking) show the address value (00 – 0F) . To change the parameter settings, follow the procedures below.

(1) Address Changing the number in the blinking digits by the vertical arrow key [↑] then push ENT key. The address setting is stored and the unit moves to the data rate select mode.

(2) Data Rate Select the data rate in the blinking digits by the vertical arrow key [↑] then push ENT key. The data rate setting is stored and the unit moves to the parity bit select mode.

Note: Selectable data rates are 12(1200bps), 48(4800bps), 96(9600bps), 19(19200bps) and 38(38400bps).

(3) Parity bit Select the parity bit in the blinking digits by the vertical arrow key [↑] then push ENT key. The parity bit setting is stored and the unit moves to the stop bit select mode.

Note: Selectable parity bit settings are 00(none), 01(odd) and 02(even).

(4) Stop bit Select the stop bit in the blinking digits by the vertical arrow key [↑] then push ENT key. The stop bit setting is stored and the unit moves to the measure mode. Note: Selectable stop bit settings are 01(1 bit) and 02(2 bits).

* If FUNC key is pushed instead of ENT key, the unit skips the rest of the communication setting and return to measure mode. Note that the settings are not stored.



CC-10 INSTRUMENT MANUAL

Crystal sensor property set mode

When sensor (or electronics unit) is replaced in the field, property numbers, which represent sensor temperature dependency, must be written manually. It is performed by entering two set of numbers into the electronics unit of CC-10. The numbers are printed on the label affixed to the sensor body. See the picture here.

Note: This procedure is only necessary when sensor/ electronics combination is changed. All newly shipped units are pre-set at the factory



Crystal sensor property set mode :

When "parameter lock" is enabled this adjustment is not possible. Make sure if lock is disabled before the programming. (Refer to 4.2)

The specific numbers are printed on the sensor body in the parenthesis followed by the serial number.

Ex. If indicated as S/N070020(4842-05), the property numbers are 4842 and 05.

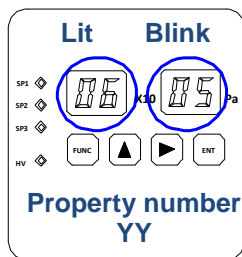
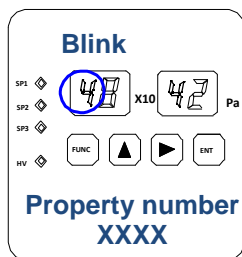
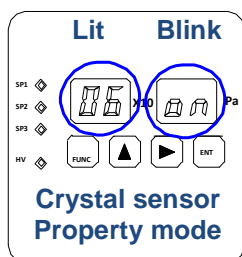

"06" display appears on the left two digits that means the gauge is in crystal sensor property set mode.

To enter the property numbers into the unit, follow the procedures below.

- (1) Push horizontal arrow key [→] to indicate the first property number. (Ex. 4842)
The current number XXXX is displayed. The first digit will blink indicating the digit is ready to change.
- (2) Change the digit by vertical arrow key [↑] then push horizontal arrow key [→] moving to the next digit.
- (3) After changing all four digits, push [ENT] key. The number will be stored and the second property number will be displayed on the exponent LED. (Left 2 digits are fixed to "06". The property number YY is displayed on the right 2 digits. Ex. 05)
- (4) Change the number by vertical arrow key [↑] then push [ENT] key to register the data. The unit returns to measure mode.



CC-10 INSTRUMENT MANUAL

5.0 Analog output

Two kind of output is available, the LOG output and the COMBINED output. The signal is comes from pin#9 and pin#1 of the I/O connector.

5.1 Log Output

Analog Output [0.5V/decade]

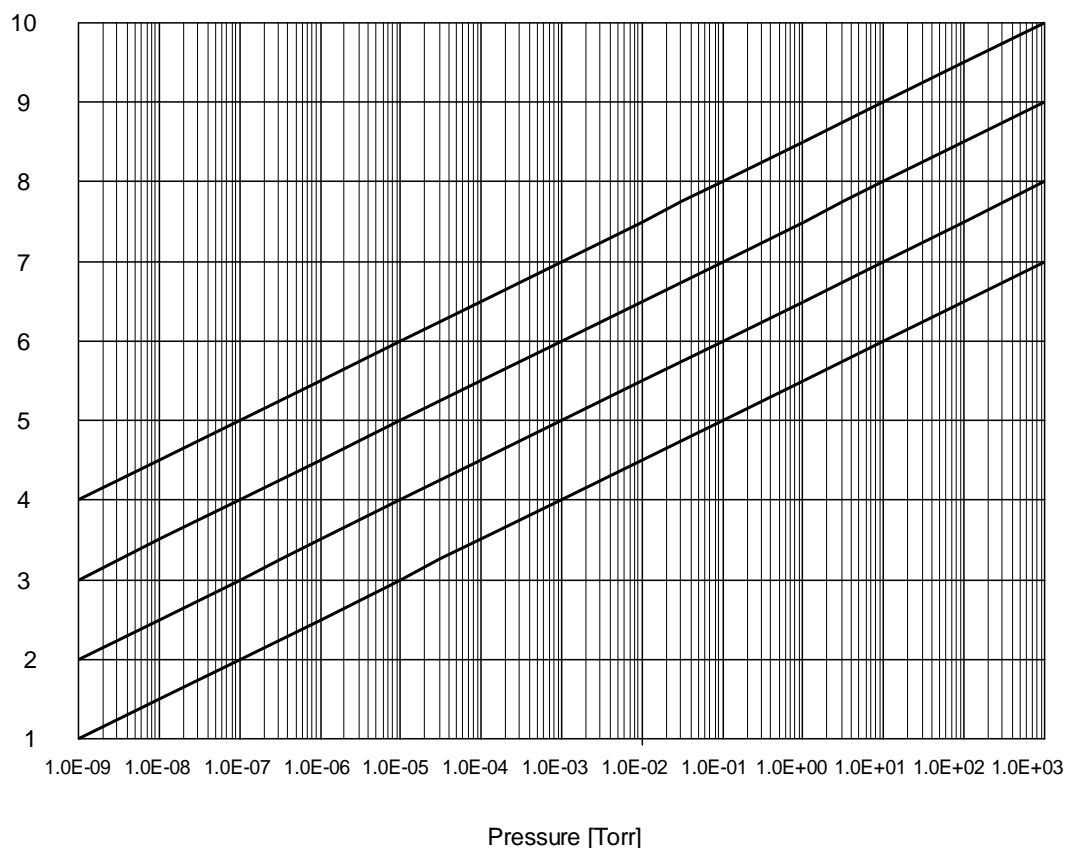

Analog output voltage V is expressed as;
 $V=0.5\log P + (n-1.5)$ where P is pressure (Torr) and n is full scale set value (n= 7, 8, 9 or 10)



**CC-10
INSTRUMENT MANUAL**

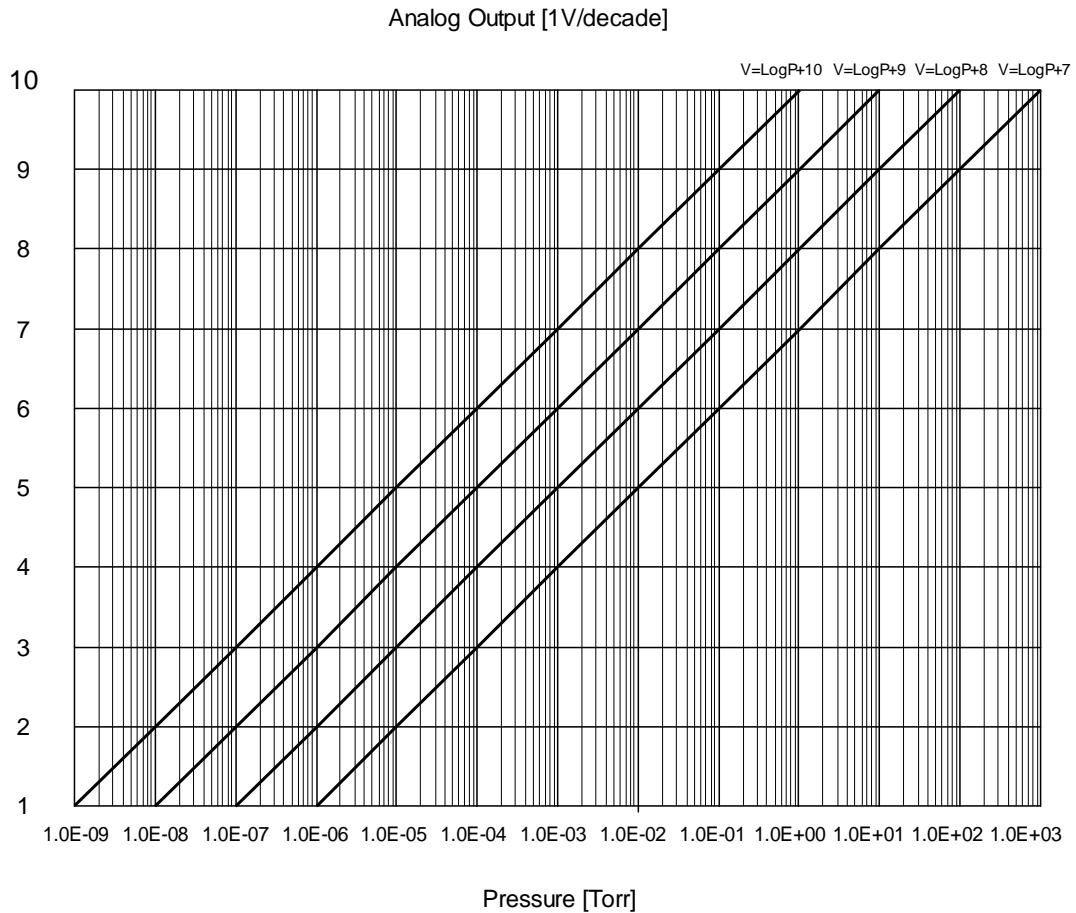

Analog output voltage V is expressed as;
 $V = \log P + (10 - n)$ where P is pressure (Torr) and n is full scale pressure value (n= 0, 1, 2 or 3)



CC-10 INSTRUMENT MANUAL

5.2 Combined Output

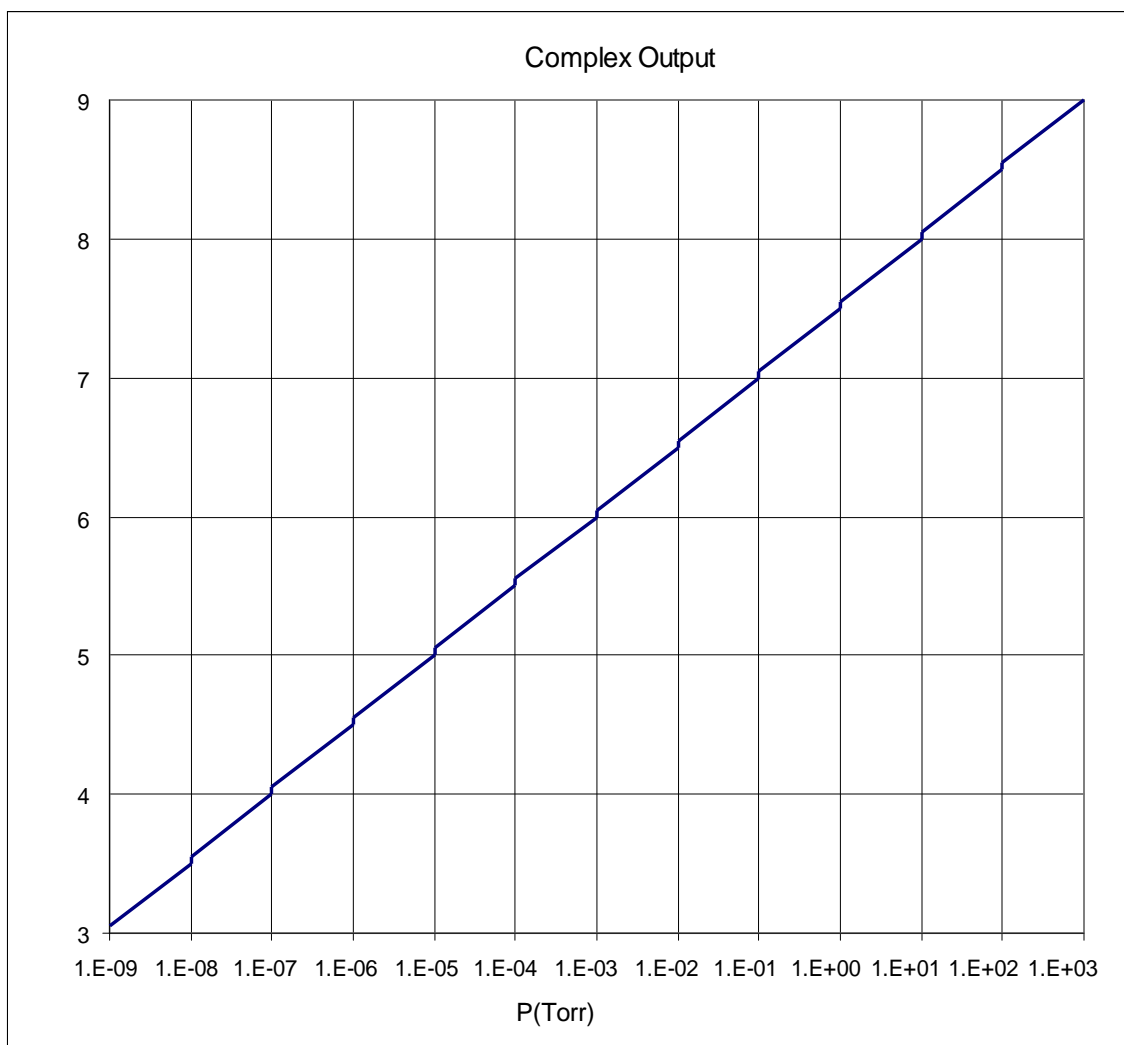

Analog output voltage V is expressed as;
for Torr unit, $V = (\text{mantissa of the pressure}/20) + (\text{exponent of the pressure} + 15)/2$

$$P = (2V - \text{int}(2V - \text{int}(2V)) * \text{antlog}[\text{int}(2V) - 14]) \text{ Torr}$$

(use X.1V when X.0 measured)



**CC-10
INSTRUMENT MANUAL**

6.0 Digital Interface

This gauge communicates with the host computer through RS-485 interface. Each communication correspondence consists of a command line sent by the host computer and a response from the gauge.

6.1 Communication Specification

Interface	EIA RS-485 compatible
Data transfer method	Synchronous/half duplicate method
Address (HEX)	0 – F
Data rate	1200/4800/9600/19200/38400
Data format	1 start bit, 8 bit (ASCII), parity bit, 1 stop bit
Error detection	Parity bit
Parity bit	None/odd/even
Stop bit	½
Transfer distance	Max 100m

6.2 Command Explanation

Command	Explanation
R(read)command	Read the set parameters of the specified unit
W(write)command	Write the set parameters of the specified unit
C(control)command	Control the specified unit
S(status)command	Read the status of the specified unit



CC-10 INSTRUMENT MANUAL

6.3 Command Format

R(read)command

1. host to gauge

1	2	3	4	5
< STX>	Address (HEX)	R	Mode	< CR>

2. gauge to host

Mode 1, 5

1	2	3	4	5	6	7	8
< STX>	Address (HEX)	R	Response mode			< CR>	

Mode 2, 3, 4

1	2	3	4	5	6	7	8	9	10	11	12
< STX>	Address (HEX)	R	Response mode								< CR>

3. Command & response

Command	Mode	Explanation	Response Data	Explanation
R	1	Read pressure unit	0001	Pa
			0002	1/133.3□Pa
			0003	1/100□Pa
R	2	Read SP1L□SP1H SP→set point1 1L - Low threshold SP → set point1 1H - High threshold	ppsePPSE	p :Mantissa of the low threshold
				s :Sign of the low threshold
R	3	Read SP2L, SP2H	E	e 0=□-□ or 1=□+□ :Exponent of the low threshold EXAMPLE ppse=7505 mean 7.5E-5 (Torr)
				P :Mantissa of the high threshold
				S :Sign of the high threshold
				0=□-□ or 1=□+□ :Exponent of the high threshold
				Note:



**CC-10
INSTRUMENT MANUAL**

Command	Mode	Explanation	Response Data	Explanation
	4	Read SP3L, SP3H		ppse must be no larger than PPSE, otherwise or the invalid value causes data error "0003" Note: The setpoint value must be between 1.0E-9 and 9.9E3(Torr or mbar), or 1.0E-7 and 9.9E5(Pa)
	5	Read Analog output set parameter	1ABB	For Log output mode A: voltage span for 1 decade 0: 0.5V/decade 1: 1.0V/decade BB: full scale voltage when A=0 BB is 07 to 10 when A=1, BB is 00 to 03 for Torr and mbar unit, or is 02 to 05 for Pa unit
2000			combined output mode	
3000			special mode for remote display unit	



CC-10 INSTRUMENT MANUAL

W(write)command

1. host to gauge

Mode 1, 5

1	2	3	4	5	6	7	8	9
< STX>	Address (HEX)	W	mode	data				< CR>

Mode 2 □ 3 □ 4

1	2	3	4	5	6	7	8	9	10	11	12	13
< STX>	Address (HEX)	W	mode	data							< CR>	

2. gauge to host

1	2	3	4
< STX>	Address (HEX)	W	< CR>

3. Command & response

Note: The gauge would not respond to the write command when it is in any parameter set mode. Make sure that the gauge is in measure mode before starting communication.

Command	Mode	Explanation	Response Data	Explanation
W	1	set pressure unit	0001	Pa
			0002	Torr
			0003	mbar
	2	set SP1L, SP1H SP1L :set point1 Low threshold SP1H set point1 High threshold	ppsePPSE	p :mantissa of SP1L s :sign of SP1L 0:□-□ or 1:□+□ e :exponent of SP1L P :mantissa of SP1H S :sign of SP1H 0:□-□ or 1:□+□ E :Exponent of SP1H Note: ppse must be no larger than PPSE, otherwise or the invalid value causes data error "003" Note: The setpoint value must be between 1.0E-9 and 9.9E3(Torr or mbar), or 1.0E-7 and 9.9E5(Pa)
3	set SP2L, SP2H			
4	set SP3L, SP3H			



**CC-10
INSTRUMENT MANUAL**

Command	Mode	Explanation	Response Date	Explanation
	5	Set analog output parameters	1ABB	1: select log output mode A: voltage span for 1 decade 0: 0.5V/decade, 1: 1.0V/decade BB: full scale voltage when A=0, BB must be 07 to 10 When A=1, BB must be 00 to 03 for Torr and mbar unit, or must be 02 to 05 for Pa unit
			2000	Select combined output mode
			3000	Select special mode for remote display unit

C (control) command

1. host to gauge

1	2	3	4	5
< STX>	Address (HEX)	C	mode	< CR>

2. gauge to host

1	2	3	4	5	6	7	8
< STX>	Address (HEX)	C	response data				< CR>

3. Command & response

command	mode	Explanation	Response data	Explanation
C	1	Trigger crystal gauge atmospheric pressure adjustment	0000	OK
			0001	ErrA
	2	Trigger crystal gauge zero adjustment	0000	OK
			0001	ErrV



CC-10 INSTRUMENT MANUAL

S (status) command

1. host to gauge

1	2	3	4	5
< STX>	Address (HEX)	S	mode	< CR>

2. gauge to host

1	2	3	4	5	6	7	8
< STX>	Address (HEX)	S	response data				< CR>

3. Command & response

command	mode	Explanation	Response data	Explanation
	1	Read pressure data	ppse	pp: mantissa s : sign (0"-" , 1= "+") e : exponent
	2	Read error status	0001	Measure
			0002	Error (ErrO, AdEr, CALE, EE Error)
	5	Read SP1, SP2, SP3 HV Status	ABCD	A : SP1 Status 0 = OFF, 1 = ON B : SP2 status 0 = OFF, 1 = ON C : SP3 Status 0 = OFF, 1 = ON D : HV Status 0 = OFF, 1 = ON
	6	Read mode status	0000	Measure mode
			0001	Program mode(parameter set mode)
	7	Read error code	ABCD	A : Erro 0 = normal, 1 = Erro B : AdEr 0 = normal, 1 = AdEr C : CALE 0 = normal, 1 = CALE D : EE Erro 0 = normal, 1 = EE Erro
	8	Read unit model	D010	CC-10
	9	Read software version	Vxxx	X : integer



**CC-10
INSTRUMENT MANUAL**

Error response

1. gauge to host

1	2	3	4	5	6	7	8
< STX>	Address (HEX)	N	Error code			< CR>	

2. error response code

Error code	Explanation
0001	Command error undefined character (other than R, W, C or S) in CMD line
0002	Mode error undefined numbers in MODE line
0003	Data error undefined numbers in DATA line
0004	Gauge is busy for it is in parameter set mode (when W or C command is sent)
0005	Gauge is uncontrollable (only S command mode 7 is acceptable)

CODE EXAMPLE

S (Status) command: Read pressure data (mode 1)
Unit address = 0

Host to gauge

< STX>	Address (HEX) 0 to F	S	Mode	< CR>
--------	----------------------------	---	------	-------

Example code:

Hex	0X02	0X30	0X53	0X31	0X0D
AScii	-	' 0'	' S'	' 1'	-



CC-10 INSTRUMENT MANUAL

7.0 Maintenance

7.1 Removing the sensor

1. Remove two screws in the back of the plastic body and take the back lid away.

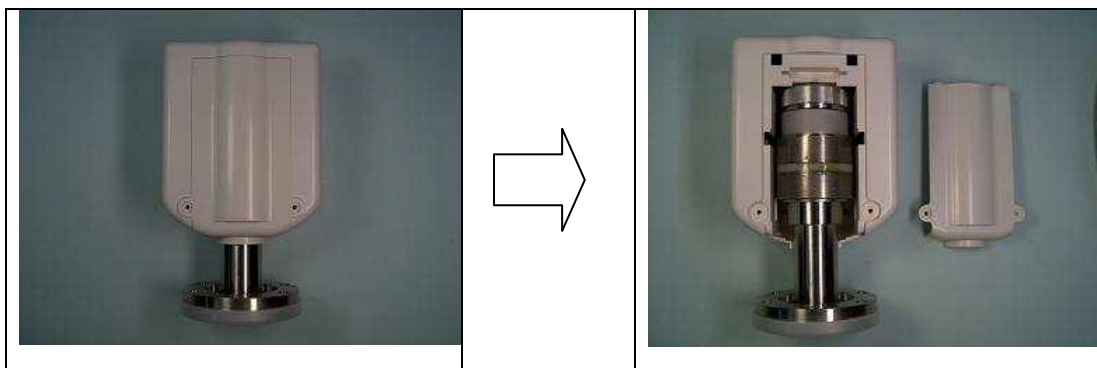

Slide the sensor toward the flange until all the pins come out of the socket. Then lift the sensor vertically from the plastic housing.

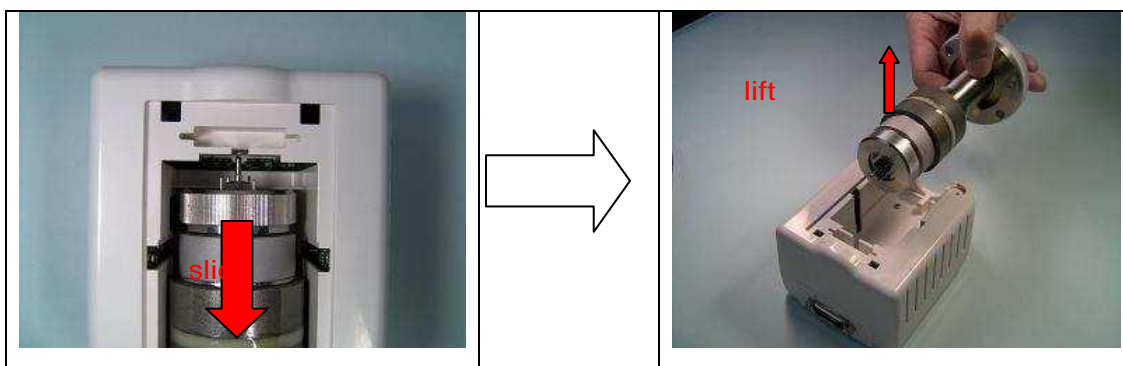

NOTE: Bake temperature: Max. 150° C (with electronics module removed).



CC-10 INSTRUMENT MANUAL

7.2 Installing the sensor

1. Put the sensor in the plastic housing fitting the anti-rotation slot on the sensor and the key on the housing together.

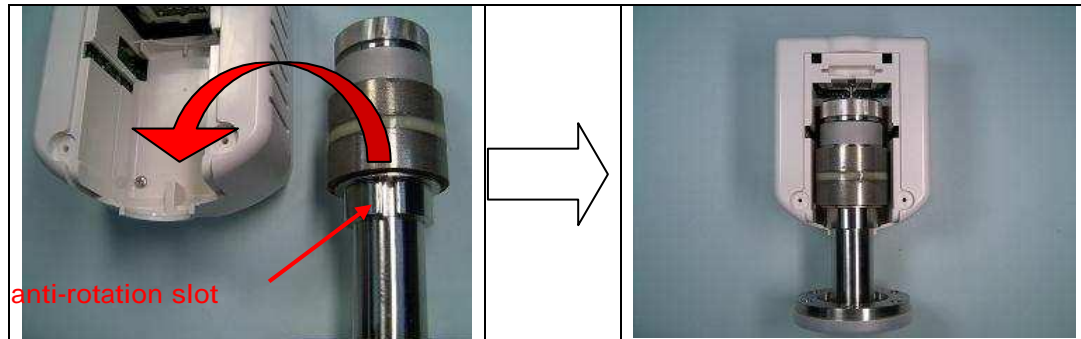

2. Slide the sensor toward the socket so that all the pins are inserted correctly into the socket. Do not push the sensor too strong. Normally the pins can be inserted smoothly with a little power.



3. If the pins are firmly inserted put the plastic cover back on the housing and fix it with two screws.
(if the pins are not fully inserted the cover cannot be shut completely.)



CC-10 INSTRUMENT MANUAL

7.3 Sensor Disassembly

1. Unscrew the nut counter clockwise, and remove the washer and the spacer.

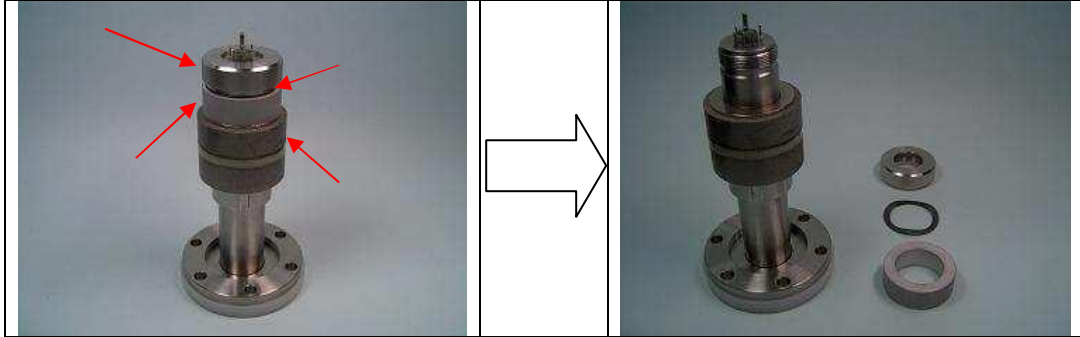

2. Pull the anode pin (located at the center) upward until the whole electrode assembly is come out of the sensor body. Remove the magnet assembly and the O-ring.
(the electrode assembly and the washer are magnetic. Keep them off the magnet so as not to be attracted by the magnet.)

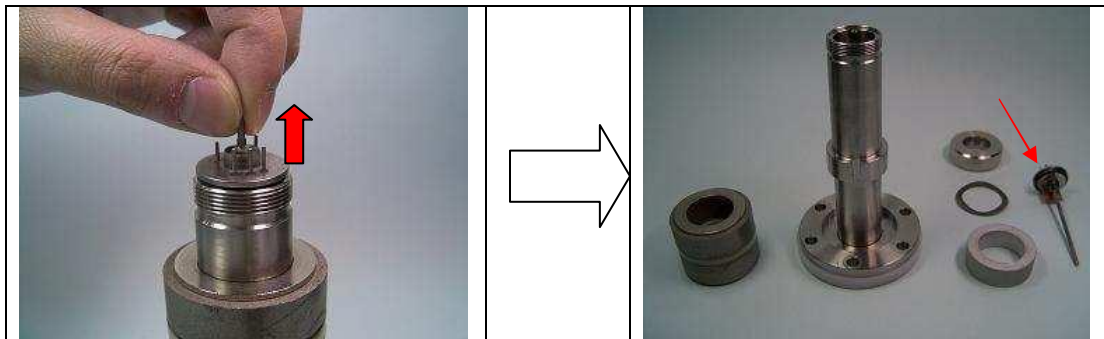

7.4 Sensor Cleaning

Polish the anode and the inner surface of the envelope with a fine emery paper.





CC-10 INSTRUMENT MANUAL

7.5 Sensor Assembly

1. Install the magnet.
2. Insert the anode assembly fitting the key into the anti-rotation hole.
3. Install the spacer, the washer and the nut in this order.
4. Tighten the nut securely so that the O-ring has an enough seal force.

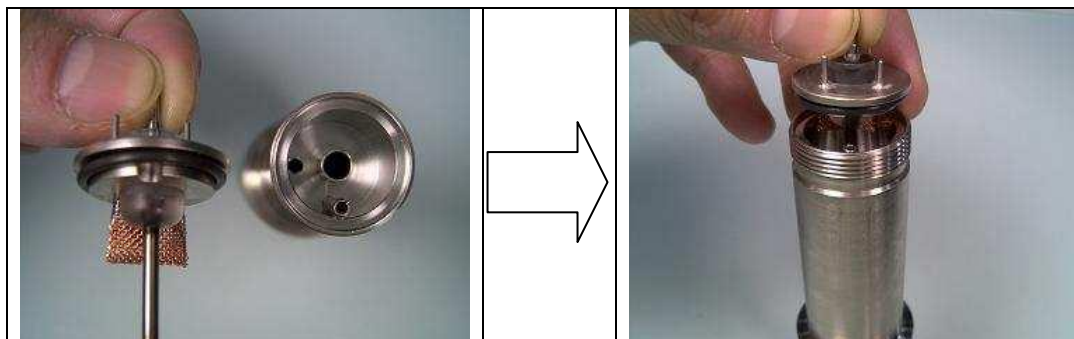

Notes: Perform the zero and the atmosphere adjustment when new anode assembly is installed.



CC-10 INSTRUMENT MANUAL

8.0 I / O Connector

The pin array and the content of the signal of external I / O connector are shown.

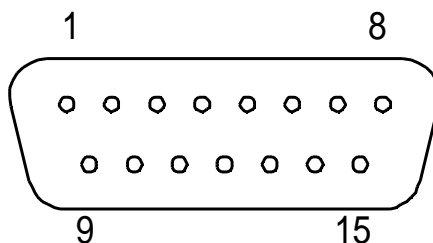

I/O

Pin number	Content	I/O	Explanation
8	+ 24V	Power input	+ 24VDC power input for CC_10
15	+ 24V COM		+ 24VDC power input common
7	EXT Vcc	Signal input	External 24V input I/O
14	Atmosphere adjustment Trigger input		When it is activated atmosphere Adjustment is triggered
6	Zero adjustment trigger input		When it is activated zero adjustment is triggered manually
13	HV inhibit signal		While it is activated cold cathode high voltage is inhibited and the gauge is measured with crystal sensor all the time
9	ANALOG OUT+	Output	Analog output
1	ANALOG OUT -		Analog ground
5	SP1	Output	Set point 1 out
12	SP1 COM		Set point 1 COM
4	SP2	Output	Set point 2 output
3	SP3		Set point 3 output
11	SP2, SP3 COM		SP2, SP3 COM (Common)
10	RS485+	Communication	
2	RS485-		



**CC-10
INSTRUMENT MANUAL**

Connecting schematics

Refer to the figure below as to the connection of the I/O.

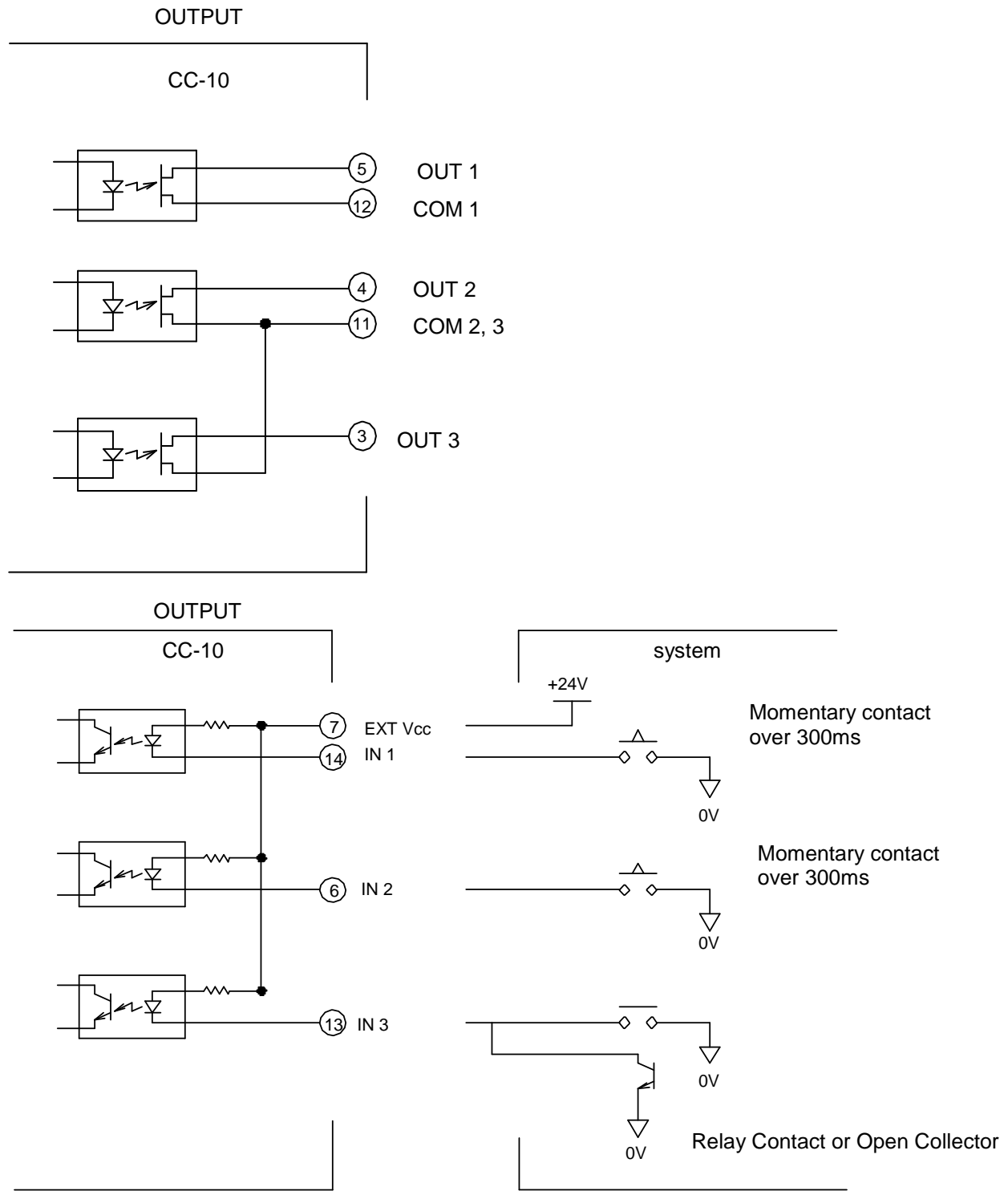



CC-10 INSTRUMENT MANUAL

9.0 Dimensions

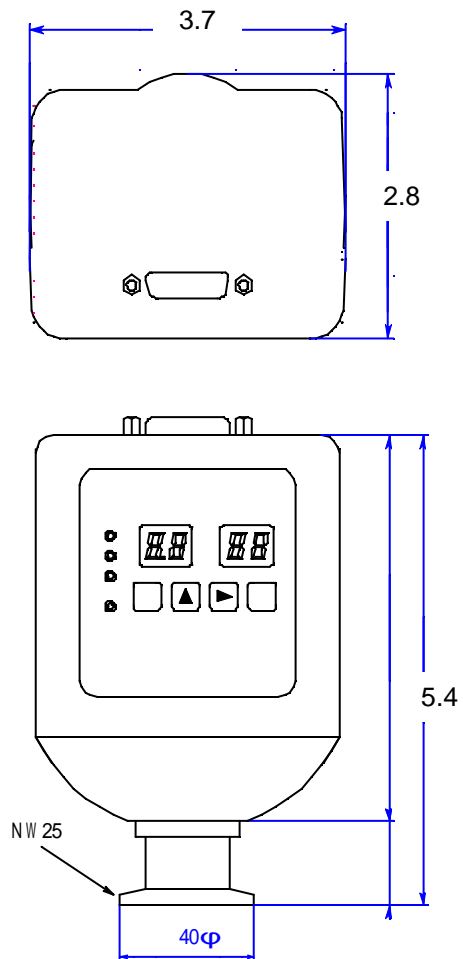



**CC-10
INSTRUMENT MANUAL**

10.0 Error message list

Error display	Malfunction	Treatment
ErrA ErrA	Atmosphere adjustment is tried at inadequate pressure (perhaps in vacuum)	Make sure the gauge is at atmosphere before adjustment
ErrU ErrU	Zero adjustment is tried at insufficient vacuum	Perform the zero adjustment in sufficient vacuum
ErrO ErrO	Crystal sensor oscillation error	Needs crystal sensor replacement. Contact service agent.
AdEr AdEr	A/D converter error	Needs electronics repair. Contact service agent
CALE CALE	A/D converter calibration error	Needs electronics repair. Contact service agent
EE Error EE Error (scroll display)	EEPROM error	Needs electronics repair. Contact service agent

11.0 Troubleshooting

Symptom	Possible Cause	Treatment
No display appears	Power failure	Check connector. Check power (24 VDC) supply
Pressure reading is unstable	Contamination in the sensor	Sensor cleaning
Pressure reading and HV LED are blinking	Cold cathode sensor is not ignited (possibly the pressure is low when power is turned on)	In low pressures cold cathode sensor tend to take a little long time to ignite. Wait until the pressure reading appears.
Pressure display does not decrease under 7.5E-3 Torr	Crystal zero is shifted	Perform manual zero adjustment when the pressure is below 4E-5 Torr



**CC-10
INSTRUMENT MANUAL**

For technical and applications assistance, please contact

Televac
2400 Philmont Avenue
Huntingdon Valley, PA 19006
Phone - (215) 947-2500
Fax – (215) 947-7464
Email: sales@televac.com
www.televac.com