

TELEVAC TELEVAC TELEVAC TELEVAC

Remote Digital Display Unit DS-10 2-7900-098



TELEVAC
A DIVISION OF THE FREDERICKS COMPANY
2400 PHILMONT AVE.
HUNTINGDONVALLEY, PA 19006

1. Installation

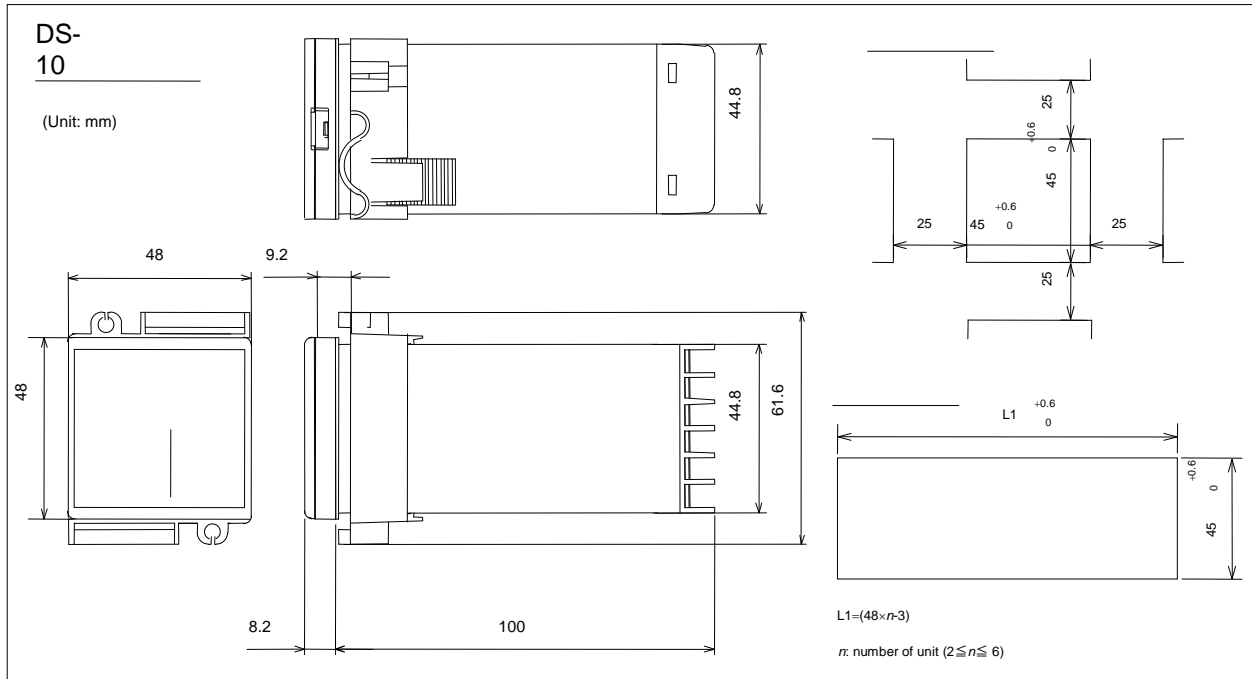

Panel thickness: 1 - 10 mm

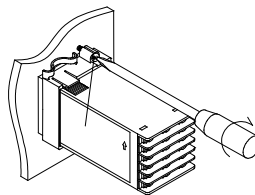
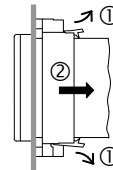
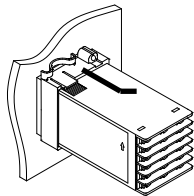

2. Wiring

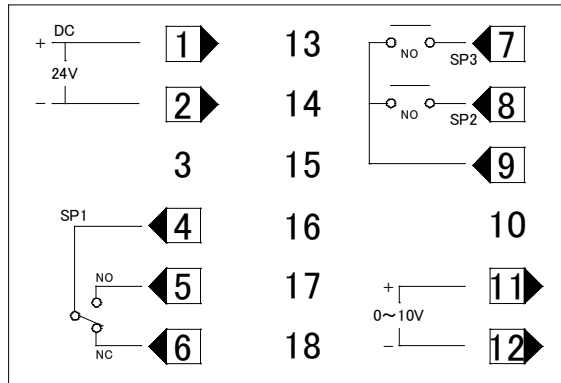

pin	function	IN/OUT	explanation
1	+24V	INPUT	24V DC Input
2	+24V COM		24V DC Common
4	SP1	OUTPUT	Setpoint 1 Common
5	SP1 NO		Setpoint 1 NO
6	SP1 NC		Setpoint 1 NC
7	SP2	OUTPUT	Setpoint 2 NO
8	SP3		Setpoint 3 NO
9	SP2, SP3 COM		Setpoint 2,3 Common
11	ANALOG IN+	INPUT	Analog Input +
12	ANALOG IN-		Analog input -

3. Specification**■ Display**

Main display	: 4 digit LED(Green)
● display range	: $4.0 \times 10^{-13} \sim 4.0 \times 10^7$ (0.3 to 10.3Vinput) Display= $10^{\{(V-6.5)/0.5\}}$
● over scale	: "oooo" blinking when input is over 10.3V
● under scale	: "uuuu" blinking when input is under 0.3V
Sub display	: 4 digit LED(orange) charctor dispaly : set points status indicator (point LED Green)

■ Input signal

Input voltage	: DC 0-10V
Sampling interval	: 0.5sec
Input impedance	: 5.1kohm

■ Setpoint

Setpoint 1	: AC250V 3A ,1c contact
Setpoint 2,3	: AC250V 1A ,1a contact

■ Ambient

Temperature	: 0 - 50°C
Humidity	: 45 -85%RH

■ Power

Input voltage	: DC21.6 - 26.4V(nominal 24V)
power consumption	: max 160mA

■ physical property

weight	: 150g
size	: 48 × 48 × 100mm

4. Panel description

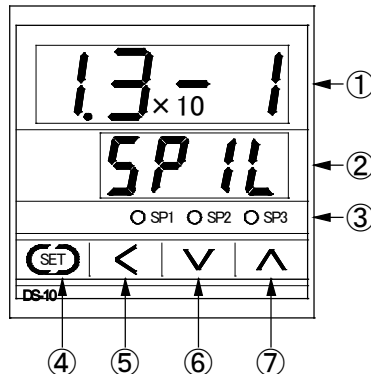

Function	Description
1 : Data display(green)	data and parameters are displayed
2 : Mode display(orange)	parameters are displayed
3: Setpoint indicator(red) (SP1, SP2, SP3)	Lit when pressure went below the setpoints
4: Set key	call and enter parameters
5: Shift key	move display digit
6: Down key	decrease displayed values
7: Up key	increase displayed values

5. Operation

When power is turned on model number and software version number are displayed for 4 seconds then go to measure mode.

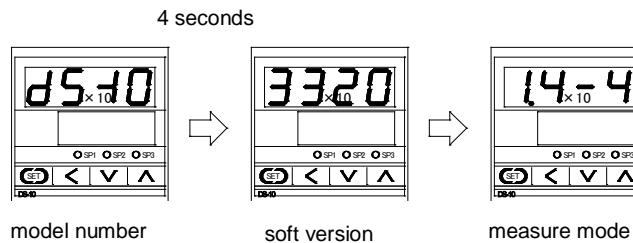

5. Operation (cont.)

(1) Measure mode

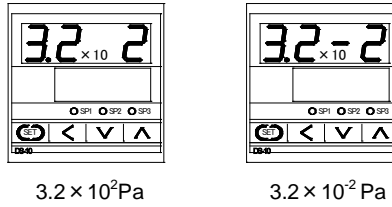

$3.2 \times 10^2 \text{ Pa}$

$3.2 \times 10^{-2} \text{ Pa}$

(2) Program mode

Push set key for program mode. Use shift key to move changing digit. Use up and down key to change the value. Push set key to register the value.

Ex. Change SP1H from 2.0×10^{-2} to 1.0×10^{-2}

Push set key and the unit goes to program mode

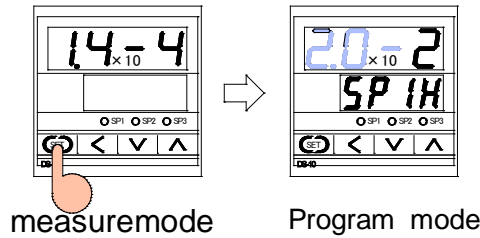

1. Blinking digit can be changed. Push shift key to move changing digit.

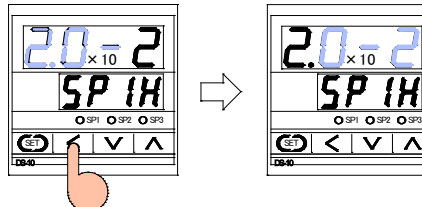

2. Push down key to change the value from "2" to "1"

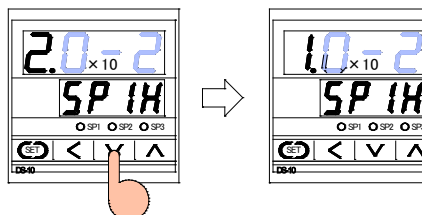

3. Push set key to register the value. The unit automatically move to the next parameter.

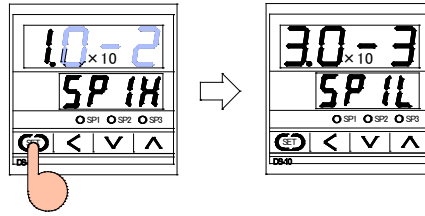

Parameters

In program mode the following parameters are displayed one by one by pushing set key.

charactor	parameter
SP 1H SP1H	SP1 upper threshold
SP 1L SP1L	SP1 lower threshold
SP 2H SP2H	SP2 upper threshold
SP 2L SP2L	SP2 lower threshold
SP 3H SP3H	SP3 upper threshold
SP 3L SP3L	SP3 lower threshold
dF dF	digital filter

**INSTRUMENT MANUAL
REMOTE DIGITAL DISPLAY UNIT**

<i>Err</i>	RAM Error	Reset by power off
blink data	over input data range	
“0000” Blinking	Over scale	
“uuuu” Blinking	Under scale	